



Components for fixed prosthesis

CATALOG/TECHNICAL MANUAL
PRICE LIST
for Dentists and Dental Technicians

DT
Bridge



8th Edition

T h e d e n t a l A t t a c h m e n t s c o m p a n y

RHEIN83

Via ZAGO 10/ABC 40128 - BOLOGNA (ITALY)
Tel. (+39) 051 244510 - (+39) 051 244396 Fax (+39) 051 245238
<http://www.rhein83.com>
direzione@rhein83.it

OT Bridge

The fixed prosthesis by Rhein83

The partially or totally edentulous patient experiences a condition of strong physical and social discomfort. Nowadays, the role of the dentist and the dental technician is of primary importance. Working in a team donates to the patient the "smile and function"; this changes, literally, the individual life allowing to reach a true aesthetic rejuvenation and a psychological benefit. The prosthetist must always evaluate, realistically, the best therapy depending on the patient characteristics. The prosthetist's job is to study the appropriate prosthetic project evaluating costs, benefits and the expectations of the patient. RHEIN 83 group, during the past 35 years of activity, has invested resources and energies in the search of simple, repeatable and reliable working protocols to make the everyday dentist and dental technician work easy and, above all, with no unexpected variables. The removable implant retained denture is a proven and reliable treatment that often remains the first choice for a professional. The fixed screwed denture is a solution for the edentulism that completely changes the patient's perspective. The project "OT BRIDGE" was born and developed in the RHEIN 83 Research and Development Department, in cooperation with some of the most prestigious Italian Universities; the low profile attachment "OT EQUATOR", born in the 2007, is an evolution of the well-known spherical system OT Cap; OT EQUATOR minimizes the vertical dimensions while preserving the same retentive and functional area.

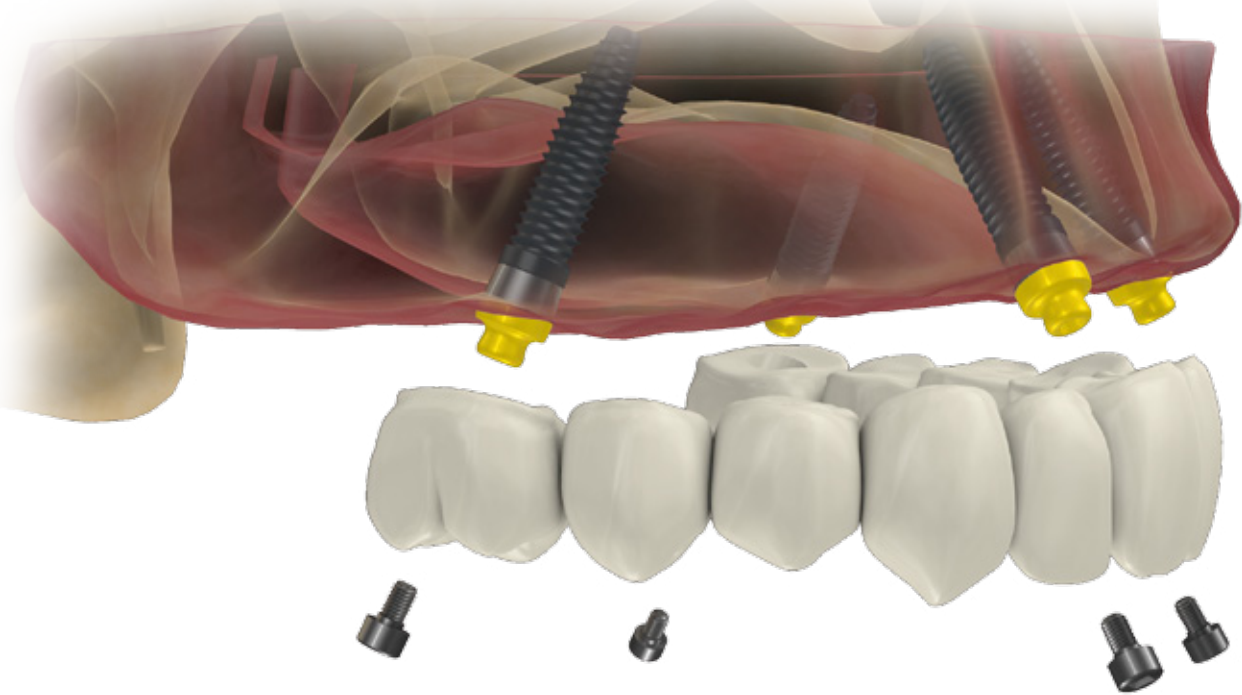

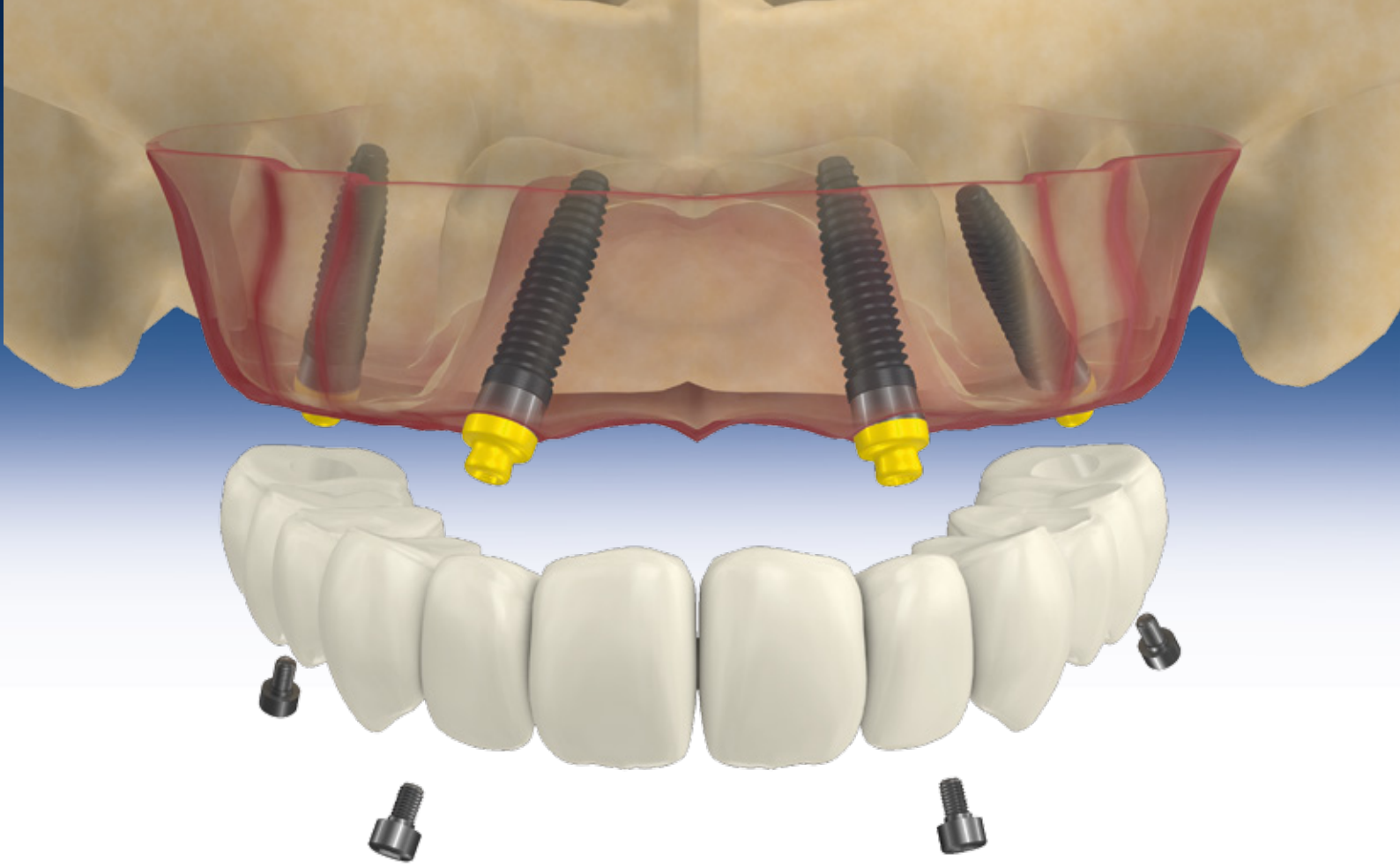

OT EQUATOR system is a global, well-established reality in the removable prosthetic protocols. Today our research allows its use in a fixed denture treatment. This is possible thanks to the Seeger system, a novelty and a revolution in the "fixed implant prosthetics" that allows to reduce the number of the prosthetic screw holes in the aesthetic areas. The sub-equatorial component, an interchangeable acetal ring, will be housed into the cylindrical "Extragate" abutment; this acetal seeger spring, is one of the original elements of this product and represents a systematic alternative to the screwed and cemented dentures.

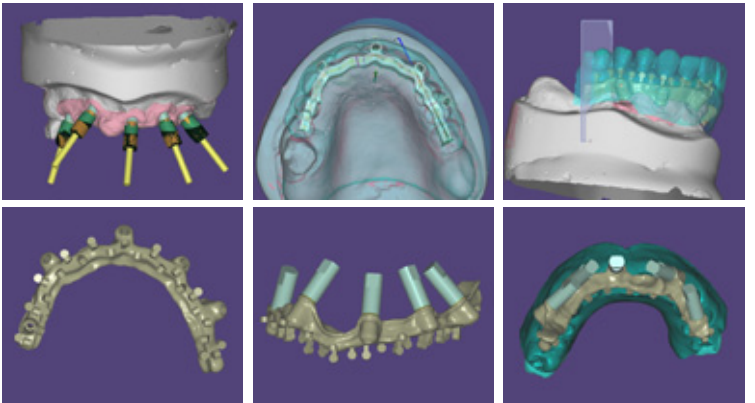

The OT Equator abutment has a blind threaded hole that does not communicate with the implant; this avoids any bacterial infiltration into the implant. The main mechanical advantage of the system is its multifunctionality in overcoming the implant divergence, even in extreme cases over 80° without resorting to components like MUA or without using time-consuming milled abutments techniques.



The real revolution offered by Ot Equator system is in the versatility; you can use the same abutment, regardless if it is a removable or fixed denture. Saving materials, tools and working time is a key point both for the clinic and the laboratory; moreover, the OT Equator system is also available in the digital dental field in the most advanced cad-cam software.



Photo courtesy by L.Cattin, E.Giunchi

TITANIUM ABUTMENTS WITH THROUGH HOLE SCREW AND CASTABLE SLEEVE

The titanium abutments with through hole screw are used in all dentures where the divergence does not create any aesthetic problem for the access to the prosthetic screw in the dental arch



TITANIUM ABUTMENTS INCLINED AT 15° AND CASTABLE SLEEVE

The Extragrade titanium abutments are used to create a fixed denture "Seeger Bridge" even on very divergent implants, exploiting, with the Seeger, the abutment undercuts as an anchoring area obtaining in this way a "snap" retention.



OT BRIDGE DIGITAL SOLUTION

SOLUTION A

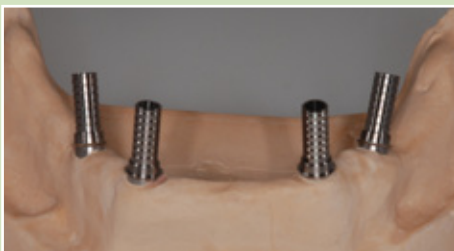

Model scan with the titanium through hole abutments for a CAD design.

SOLUTION B



Scan of the model with the scan abutments for the digital flow. The top beveled surface matches with the Extragrade incision of the titanium abutment; the Extragrade must always be positioned in correspondence of the maximum undercut created by the tilted implant.

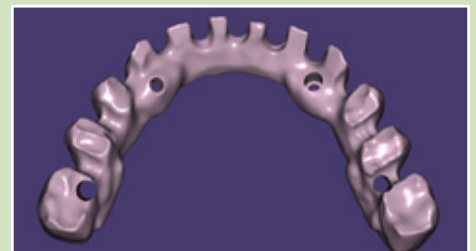

Digital structure CAD designed, ready to be realized. The Extragrade titanium abutments will be cemented into the holes.

TITANIUM ABUTMENTS WITH AND WITHOUT SCREW + CASTABLE SLEEVE

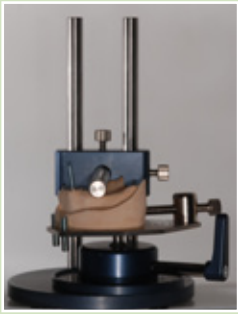

Model analysis with the Rhein83 parallelometer.



Implants divergency analysis.



Analysis of the teeth set-up dimensions. The project is made with the titanium abutments with screws, sleeves to be bonded and titanium abutments inclined at 15° without screws.

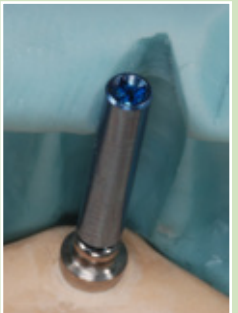

Long screw on Ot Equator analog to check where the prosthetic screw hole will be located.



Extragrade Titanium Abutment inclined at 15°. The white Seeger must be positioned with its open side towards the Extragrade bevel.

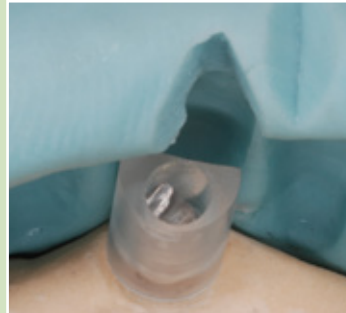

In case of an excessive implant inclination, it is suggested to use an Extragrade titanium abutment inclined at 15° without screw and a castable sleeve to be bonded. The abutment will be retained by the white Seeger only. The percentage of abutments without screws should be limited to 25% of the total number of abutments (in this case 1 out of 4).



It is important to position the flat surface of the titanium abutment in correspondence with the undercut created by the inclination of the implant; the flat surface indicates the location of the Extragrade bevel, which will allow the denture to overcome the undercuts created by the tilted implant.



The open side of the Seeger must be positioned towards the Extragrade, a position that is forced by an anti-rotational device located into the abutment.



The castable sleeve allows the construction of a structure that later will be cast. Then the Extragrade titanium abutments will be passively bonded.



The castable structure must be as passive as possible. Passivity is facilitated by the use of castable gingival connectors that can be adapted, cut and shaped, trying to leave as little space as possible between these and the implant abutment.



The castable structure ready to be cast.



Before bonding, the fitting of the framework should be tested. It is important to cement the elements one at a time. The use of the Ot Cem composite cement from Rhein83 is recommended.



Place the Extragrade titanium abutment with the short screw onto the Ot Equator attachment, **making sure to place the flat surface of the titanium abutment in correspondence with the undercut created by the implant inclination.** It is recommended to protect the screw hole with a wax pin.



The cement should be put on the external part of the Extragrade titanium abutment and into the internal surface of the metal cast sleeve. The wax pin will seal and protect the entrance of the prosthetic screw.



Alternatively: screw the titanium abutment and smear the screw with vaseline, keeping the Extragrade abutment in the exact position; respect the setting time of the composite cement as reported in the instructions for use.



Work polished, assembled, ready to be coated with the aesthetic material. Please note the white Seegers inserted in the Extragrade abutment housing.

CASTABLE ABUTMENT WITH PASSING THROUGH HOLE FOR SCREW AND SEEGER



CASTABLE ABUTMENT WITHOUT PASSING THROUGH HOLE FOR SCREW AND SEEGER



CASTABLE ABUTMENTS

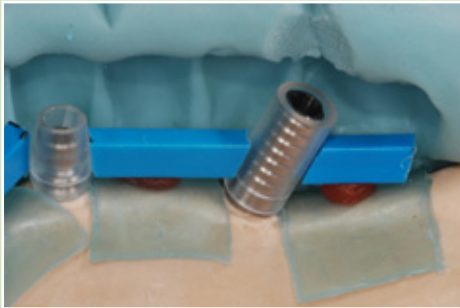

Model analysis with the help of the diagnostic teeth set-up mask. Where the space is limited, the Extragrade castable abutment is advisable which, while allowing a passive insertion, overcomes the divergencies and can be shaped accordingly to the available spaces.

Into the castable abutment with screw, likewise the titanium abutment with screw, you can see the bevel called Extragrade.

The Extragrade position is indicated by the flat surface outside the abutment; this must always be positioned in correspondence with the undercut created by the tilted implant.

Cast and sand-blasted bar with 150 micron particle size aluminum dioxide at 3 atmospheres.



Detail of the castable abutment after the casting and the sandblasting.

Special bur to clean any oxides, micro-imperfections or bubbles inside the Seeger housing in those areas where the sandblasting is not effective.

Test with the OT Equator analog, before proceeding with the trimming and the polishing of the framework.

Framework polished and ready to be finished with the aesthetic covering.



Insert the Seeger as shown in the photo by placing the open section in correspondence with the undercut created by the inclination of the implant.

Work finished; caudal view.

Vestibular view. Please note that thanks to the pre-angled abutments and the Seeger there are no vestibular prosthetic screw holes.

Denture completed.

Ideal solution for cases with immediate loading or for all cases where a temporary device is required to provide an excellent structural strength.

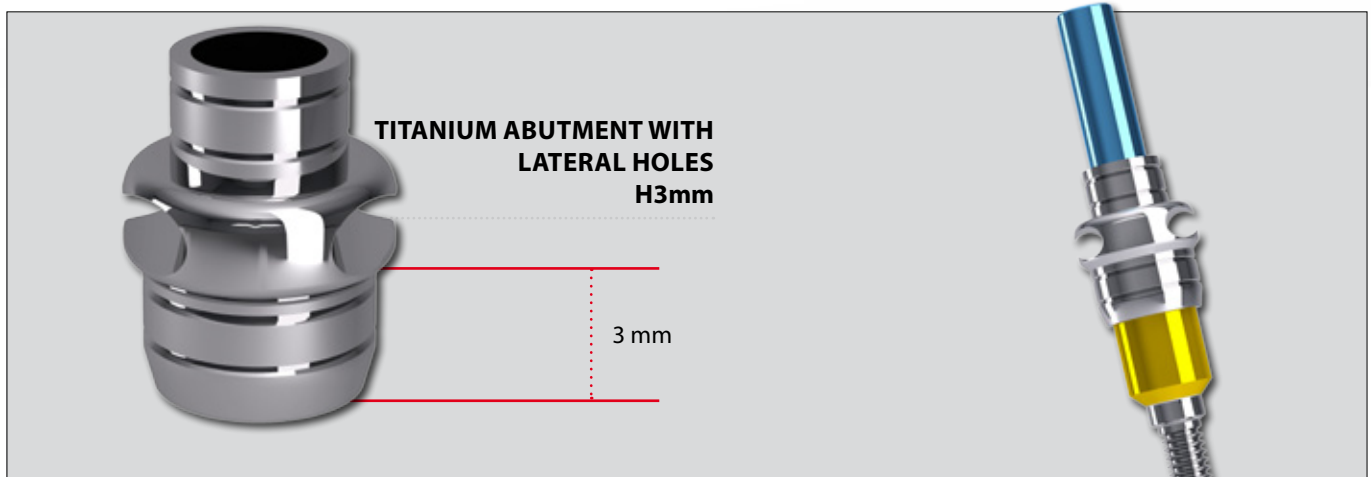
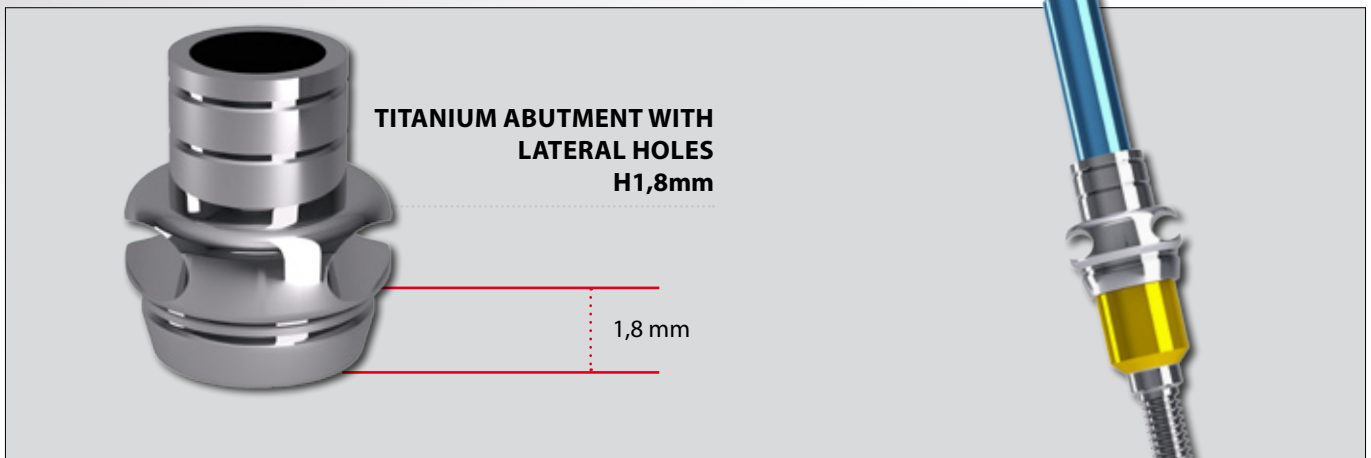

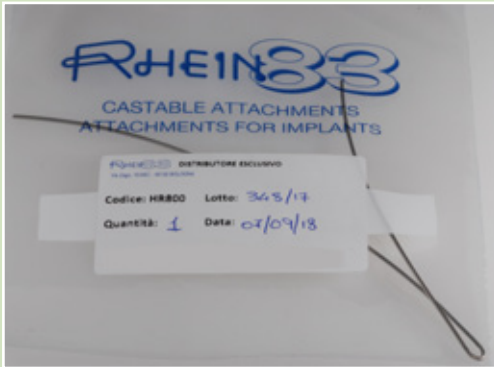

Titanium wire for the construction of wire reinforced frameworks.



Titanium wire inserted into the lateral hole (Ø 1mm) of the abutment.

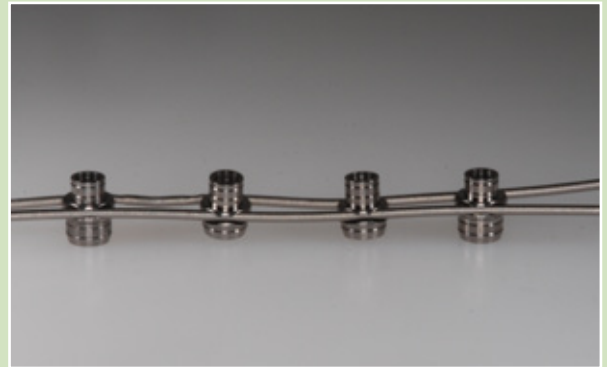

Insert the titanium wire into all lateral holes of the titanium abutments.



Screw the titanium abutments with lateral holes one at a time and bend the titanium wire accordingly so to follow the correct gingival and prosthetic profile.



The teeth are positioned and shaped accordingly to the mask and the available spaces.



The titanium abutments with lateral holes can be adapted accordingly to the available spaces and being properly opacified and then embodied with self-curing aesthetic resin.



The titanium abutments with lateral holes do not have the Extragrade bevel, so if necessary it can be made manually, once the work is finished, paying the utmost attention in doing it always on the divergent side.



It is fundamental to position the Seegers so that their open side is in correspondence with the undercut created by the tilted implant.



Insertion of the Seegers into all the titanium abutments.



Even with the temporary dentures, the insertion patterns must be followed accordingly to the implant divergences both on the model and into the patient's mouth.



In case of strong disparallelisms (like an all-on-four) it is advisable to insert the bridge first on the most inclined attachments, which in this case are those located on the incisor area, then moving to the posterior area, making the denture snap into the correct position.



The resin-wire-reinforced bridge is finished and delivered to the dentist in about 2 hours.

HEALING ABUTMENTS



SCREW AND HEALING RING



OT EQUATOR SEEGER AND HEALING RING

OT EQUATOR SEEGER



OT EQUATOR SEEGER AND SELF-EXTRACTING PEEK RING

OT EQUATOR STAINLESS STEEL ANALOGS



Ø 4 mm



Ø 5 mm

IMPRESSION COPINGS



TITANIUM LONG IMPRESSION COPING WITH LONG SCREW FOR PICK-UP IMPRESSION



TITANIUM IMPRESSION COPING WITH SCREW FOR PICK-UP IMPRESSION



PLASTIC IMPRESSION COPING



PLASTIC MINI IMPRESSION COPING

OT EQUATOR ANALOGS WITH TITANIUM SCREW FOR CAD/CAM



Ø 4 mm

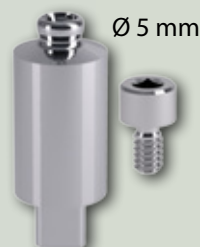

Ø 5 mm

HEALING ABUTMENTS



Option 1: Healing screw screwed onto the Ot Equator abutment.

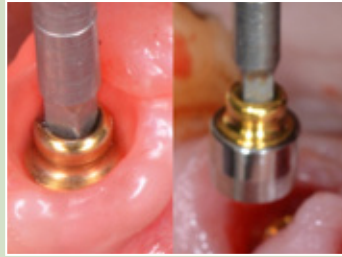

Option 2: Ot Equator Seeger screwed onto the Ot Equator abutment.



Example of the two options screwed onto the Ot Equator abutment.

OT EQUATOR SEEGER



Insertion of the Ot Equator seeger inside the self-extracting peek ring already in position.



Like the titanium seeger screw, the Ot Equator seeger also removes the self-extracting peek ring during unscrewing.



2 threaded Ot Equator for cam and 2 Ot Equator seeger in position, in case of divergence (the Ot Equator seegers follow the direction of the implants) the use of Smart box housings is recommended.

OT EQUATOR STAINLESS STEEL ANALOGS



Elastomer impression with Ot Equator analogs matching the diameter of the inserted implants.

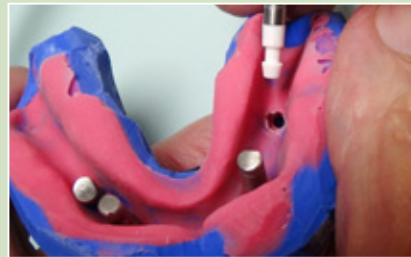

Often the plastic impression copings remain in the mouth; remove and reposition them into the impression; the right position can be easily found before pouring the model.

IMPRESSION COPINGS



Impression with the titanium impression copings with screws.

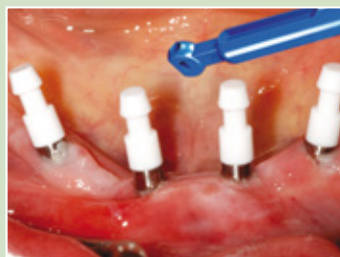

Impression with the plastic impression copings.



Impression with the plastic mini impression copings, ideal solution when there is not enough vertical dimension.

OT EQUATOR ANALOGS WITH TITANIUM SCREW FOR CAD/CAM



In case of an immediate loading denture, the impression can be taken with the mini impression copings and collecting all the necessary data just after the surgery.



Upper model cast in quick-setting plaster and silicone mask.



Lower model cast in quick-setting plaster.



STAINLESS STEEL JOINT



TITANIUM JOINT



STAINLESS STEEL CLYNDER



TITANIUM CLYNDER



STAINLESS STEEL
RETENTIVE CLYNDER



TITANIUM
RETENTIVE CLYNDER

Telescopic bar designed for screwed structures without stress on implants for immediate loading dentures using the bonding technique without casting and welding; available with retentive cylinders (optional) for a better tooth retention. the system can also be used for screwed bridges. Available in medical grade stainless steel and in grade 5ELI Titanium. The Titanium version joints can be welded to the Extragrade abutments.



JOINT

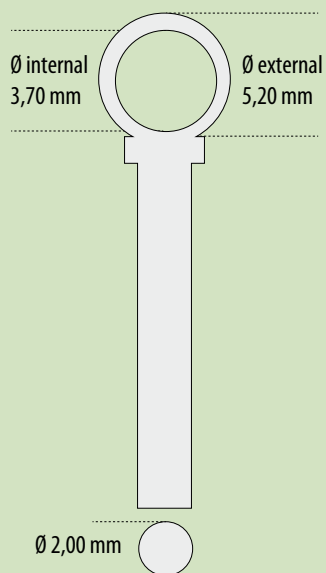

CYLINDER WITH RETENTIVE PINS

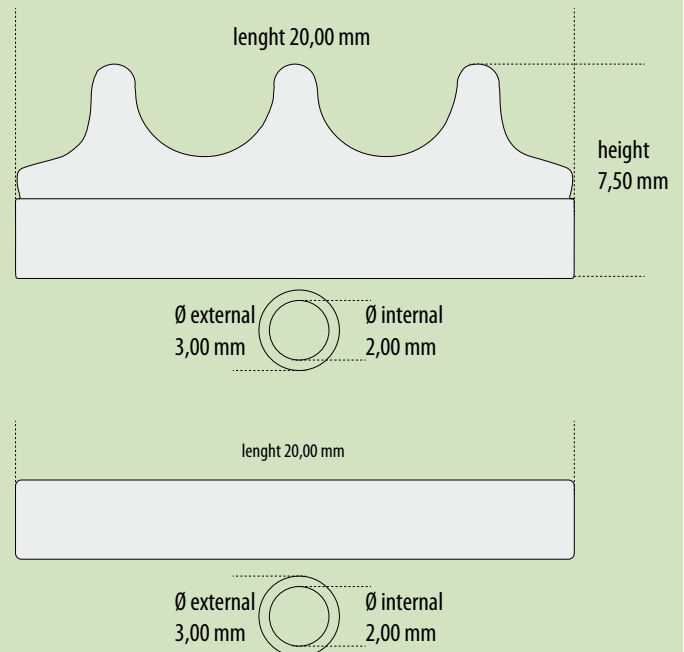

CYLINDER

OT BRIDGE

Extragate and seeger anti-rotation systems

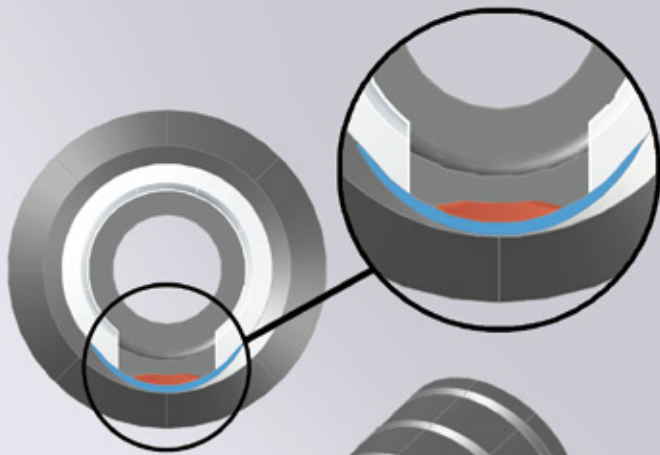

● Seeger anti-rotation system

● Extragate system

● Reference flat milled surface

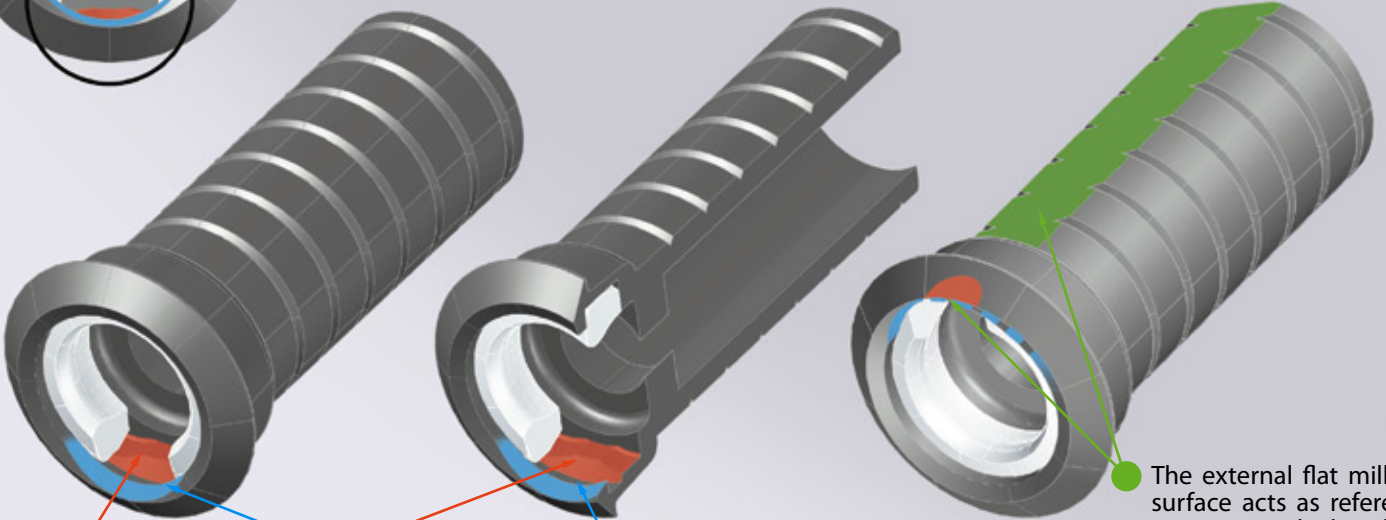

The external flat milled surface acts as reference point and identifies the position of the internal extragate flaring.

● The anti-rotationality of the seeger ring is possible thanks to the stop inside the prosthetic abutment which prevents any seeger rotation

● The OT Bridge prosthetic abutment must be positioned with its extragate flaring in correspondance of the implant undercut.

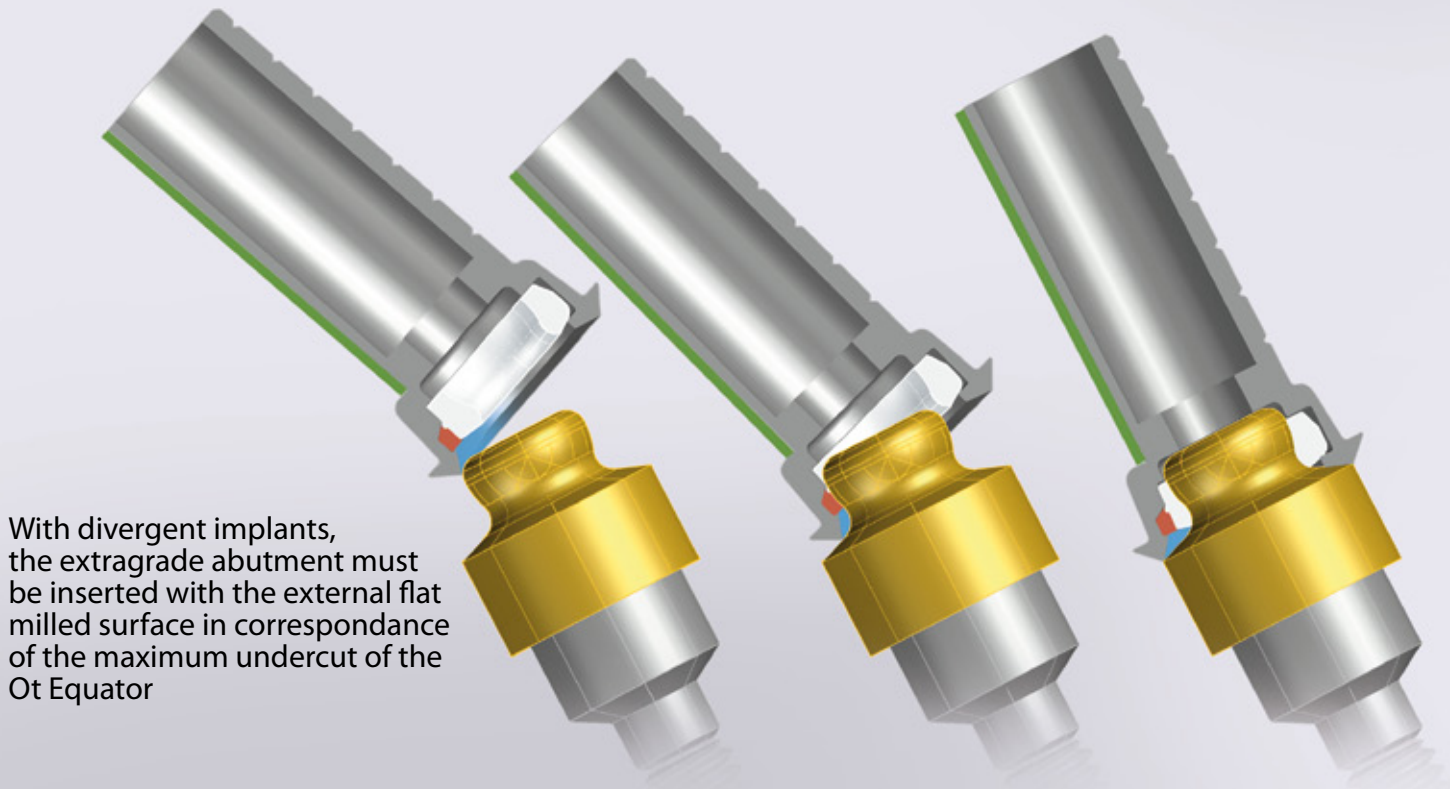

With divergent implants, the extragate abutment must be inserted with the external flat milled surface in correspondance of the maximum undercut of the Ot Equator

The autoclavable Set42 (BE42 + 42 Ot Equator of your choice) is suitable when an implant immediate loading procedure is preferred. It allows, indeed, to have available and ready to use different heights of OT Equator abutments. The Set 42 can be customized accordingly to the preferred brands, diameters and heights.



The Set 42 is produced and shipped within 5 days from the order, it is mandatory to indicate: implant brand, implant diameter and cuff height.

Available heights:

for internal hexagon implants from 0.5 to 7mm
for external hexagon implants from 2 to 7mm

OT EQUATOR ABUTMENT



Ref. 030

- 1 OT EQUATOR TITANIUM ABUTMENT WITH TiN COATING

€ 80,00

SET 42



Ref. BE42
+ n° 42 Ot Equator
(Ref. 030 to be chosen)

- 1 ASSORTMENT SET (autoclavable) + 42 OT EQUATOR +TiN ABUTMENTS
THE SET42 CAN BE CUSTOMIZED ON THE BASIS OF THE IMPLANTS BRANDS, IMPLANTS DIAMETERS AND CUFF HEIGHTS DESIRED. PLEASE INDICATE, IN THE ORDER, THE QUANTITY AND THE ABOVE SPECIFICATIONS FOR EVERY KIND OF ABUTMENT.
(Tools not included in the set)

€ 3000,00



Ref. BE42

- 1 EMPTY BOX FOR ASSORTED OT EQUATOR ABUTMENTS
(ABUTMENTS NOT INCLUDED)

€ 120,00

ABUTMENTS FOR FIXED PROSTHESIS



Ref. MTSEG

Ø3,5mm

Ref. MT40SEG

Ø4,0mm

Ref. MT50SEG

Ø5,0mm

EXTRAGRADE TITANIUM ABUTMENT

SET CONTENT

- 1 EXTRAGRADE TITANIUM ABUTMENT TO BE CEMENTED h9,5mm
- 1 TITANIUM SCREW h2mm
- 2 WHITE SEEGER WITH HANDLE
- 1 PINK SEEGER WITH HANDLE

€ 39,00



Ref. MMSEG

Ø3,5mm

Ref. MM40SEG

Ø4,0mm

MINI EXTRAGRADE TITANIUM ABUTMENT

SET CONTENT

- 1 MINI EXTRAGRADE TITANIUM ABUTMENT TO BE CEMENTED h5,7
- 1 TITANIUM SCREW FOR MINI EXTRAGRADE TITANIUM ABUTMENT
- 2 WHITE SEEGER WITH HANDLE
- 1 PINK SEEGER WITH HANDLE

€ 39,00



Ref. MTSFEG

Ø3,5mm

Ref. MTEG15SF

Ø4,0mm

EXTRAGRADE TITANIUM ABUTMENT INCLINED AT 15°

SET CONTENT

- 1 EXTRAGRADE TITANIUM ABUTMENT INCLINED AT 15° TO BE CEMENTED
- 1 TITANIUM SCREW FOR INCLINED ABUTMENT
- 2 WHITE SEEGER WITH HANDLE
- 1 PINK SEEGER WITH HANDLE

€ 65,00



Ref. CMEG40C

Ø4,0mm

EXTRAGRADE CASTABLE ABUTMENT

SET CONTENT

- 1 EXTRAGRADE CASTABLE ABUTMENT WITH HOLE
- 1 TITANIUM SCREW h2mm
- 2 WHITE SEEGER WITH HANDLE
- 1 PINK SEEGER WITH HANDLE

€ 39,00



Ref. MCEG15SF

Ø4,0mm

EXTRAGRADE CASTABLE ABUTMENT WITHOUT HOLE

SET CONTENT

- 1 EXTRAGRADE CASTABLE ABUTMENT WITHOUT HOLE (ONLY AVAILABLE WITH Ø4,0mm)
- 2 WHITE SEEGER WITH HANDLE
- 1 PINK SEEGER WITH HANDLE

€ 39,00



Ref. CMTFP

h18mm

Ref. CMTB30FP

h30mm

TITANIUM ABUTMENT WITH LATERAL HOLES FOR TEMPORARY RESIN BRIDGE WITH WIRE-REINFORCMENT

SET CONTENT

- 1 TITANIUM ABUTMENT WITH LATERAL HOLES (ONLY AVAILABLE WITH Ø3,5mm)
- 1 TITANIUM SCREW h2mm
- 2 WHITE SEEGER WITH HANDLE
- 1 PINK SEEGER WITH HANDLE

€ 39,00



Ref. MT40GL

Ø4,0mm

TITANIUM NORMO ABUTMENT FOR INTRA ORAL WELDING

SET CONTENT

- 1 TITANIUM NORMO ABUTMENT FOR INTRA ORAL WELDING h9,5mm Ø4,0mm
- 1 TITANIUM SCREW h2mm
- 2 WHITE SEEGER WITH HANDLE
- 1 PINK SEEGER WITH HANDLE

€ 39,00

IMPRESSION COPINGS



Ref. 144TLE

- 1 TITANIUM LONG IMPRESSION COPING + TITANIUM LONG SCREW

€ 44,00



Ref. 144TTE

- 1 TITANIUM IMPRESSION COPING + TITANIUM SCREW

€ 44,00



Ref. 144MTE

- 2 IMPRESSION COPINGS FOR INDIVIDUAL TRAY

€ 36,00



Ref. TPM2

- 2 MINI IMPRESSION COPINGS h3,7mm

€ 28,00

OT EQUATOR SCAN ABUTMENT



Ref. 145SAE

- 1 OT EQUATOR TITANIUM SCAN ABUTMENT + TITANIUM SCREW

€ 85,00

HEALING ABUTMENTS



Ref. 159VAG

SCREW AND HEALING RING

SET CONTENT

- 1 HEALING TITANIUM SCREW
- 1 TITANIUM SELF-EXTRACTING HEALING RING

€ 29,00



Ref. 159EAG

OT EQUATOR SEEGER AND HEALING RING

SET CONTENT

- 1 TITANIUM + TIN OT EQUATOR SEEGER
- 1 TITANIUM SELF-EXTRACTING HEALING RING

€ 35,00



Ref. 159VEA

- 1 OT EQUATOR SEEGER
(for self-extracting peek ring or titanium self-extracting healing ring)

€ 25,00

LABORATORY ANALOGS



Ref. 144AE

- 2 LABORATORY ANALOGS ø 4mm

€ 38,00

Ref. AI502

- 2 LABORATORY ANALOGS ø 5mm

€ 38,00



Ref. 144AVC4

- 1 LABORATORY ANALOG WITH SCREW FOR CAD/CAM ø 4mm

€ 23,00

Ref. 144AVC5

- 1 LABORATORY ANALOG WITH SCREW FOR CAD/CAM ø 5mm

€ 23,00

CUTTING GUIDES SET FOR EXTRAGRADE ABUTMENTS



Ref. CGDA

SET CONTENT

- 1 CUTTING GUIDE FOR EXTRAGRADE ABUTMENT h 6,8mm
- 1 CUTTING GUIDE FOR EXTRAGRADE ABUTMENT h 4,8mm
- 1 CUTTING GUIDE FOR EXTRAGRADE INCLINED ABUTMENT h 5,0mm
- 1 TIGHTENING SCREW FOR CUTTING GUIDE

€ 85,00

SCREWS



Ref. 147VME

- 1 TITANIUM SCREW FOR EXTRAGRADE ABUTMENT
(for screwdriver/stem for inclined Channel)

€ 15,00



Ref. 146VMI

- 1 SPHERICAL TITANIUM SCREW FOR INCLINED ABUTMENT
(for screwdriver/stem for inclined Channel)

€ 15,00



Ref. 148VCM

- 1 TITANIUM SCREW FOR MINI EXTRAGRADE ABUTMENT
(for screwdriver/stem for inclined Channel)

€ 15,00

Ref. VC

- 1 TITANIUM SCREW h2mm (for extragrade abutment)

€ 15,00

Ref. VM

- 1 TITANIUM SCREW h6mm (for extragrade abutment)











€ 15,00

Ref. VXL

- 1 TITANIUM SCREW h11,5mm (for extragrade abutment)

€ 15,00

TOOLS

	Ref. 774CHE	• 1 SQUARE SCREW DRIVER + OT EQUATOR HOLDER (SQUARE TIP 1.25mm) (USABLE WITH THE MANUAL TORQUE WRENCH)	€ 42,00
	Ref. 775CLE* (*long version)		
	Ref. 760CSC	• 1 SCREWDRIVER/STEM FOR ANGULATED CHANNEL FOR TORQUE CONTROLLER CONTRA ANGLE (SQUARE 1.25mm)	€ 39,00
	Ref. 760CS* (*long version)		
	Ref. 760ACC	• 1 SCREWDRIVER/STEM FOR ANGULATED CHANNEL ADAPTER (USABLE WITH MANUAL TORQUE WRENCH)	€ 55,00
	Ref. 774HC	• 1 INTERCHANGEABLE HOLDER	€ 8,00
	Ref. 760CE	• 1 OT EQUATOR SCREWDRIVER/STEM READY FOR HOLDER, FOR TORQUE CONTROLLER CONTRA ANGLE (SQUARE 1.25mm)	€ 39,00
	Ref. 760CRD-US	• 1 MANUAL TORQUE WRENCH For Ot Equator and Sphero Block/Flex (TORQUE RANGE: 15-35 Ncm - MAX. ALLOWED 50Ncm)	€ 240,00
	Ref. 124ICP	• 1 UNIVERSAL HANDLE	€ 15,00
	Ref. CGD48	• 1 CUTTING GUIDE FOR EXTRAGRADE ABUTMENT h4,8mm	€ 27,00
	Ref. CGD68	• 1 CUTTING GUIDE FOR EXTRAGRADE ABUTMENT h6,8mm	
	Ref. CGA5	• 1 CUTTING GUIDE FOR EXTRAGRADE INCLINED ABUTMENT h5,0mm	€ 27,00
	Ref. VCG	• 1 TIGHTENING SCREW FOR CUTTING GUIDE	€ 15,00

MEDICAL STEEL T-BAR

	Ref. G80A	• 4 MEDICAL STEEL JOINTS	€ 32,00
	Ref. T20A	• 4 MEDICAL STEEL CYLINDERS	€ 8,00
	Ref. T20Ai	• 4 MEDICAL STEEL RETENTIVE CYLINDERS	€ 12,00

TITANIUM T-BAR

	Ref. G80T	• 4 TITANIUM JOINTS	€ 37,00
	Ref. T20T	• 4 TITANIUM CYLINDERS	€ 20,00
	Ref. T20Ti	• 4 TITANIUM RETENTIVE CYLINDERS	€ 24,00

TOOLS T-BAR

	Ref. T-APLUS	• 2 T-BAR ADAPTERS	€ 48,00
--	---------------------	--------------------	---------

CUFF HEIGHT MEASURER



Ref. 008MBG

SET CONTENT

- 1 CUFF HEIGHT SLIDER GAUGE
- 1 CUFF HEIGHT FIXED ROD GAUGE
- 1 SILICON RING DISPENSER
- 20 SILICON RINGS

€ 80,00

SPARE PARTS



Ref. RMTSFEG

- 1 EXTRAGRADE TITANIUM ABUTMENT INCLINED AT 15° Ø 3,5mm

Ref. RMTEG15SF

- 1 EXTRAGRADE TITANIUM ABUTMENT INCLINED AT 15° Ø 4,0mm

€ 54,00



Ref. RMTSEG

- 1 EXTRAGRADE TITANIUM ABUTMENT Ø 3,5mm

Ref. RMT40SEG

- 1 EXTRAGRADE TITANIUM ABUTMENT Ø 4,0mm

Ref. RMT50SEG

- 1 EXTRAGRADE TITANIUM ABUTMENT Ø 5,0mm

€ 29,00



Ref. RMMSEG

- 1 MINI EXTRAGRADE TITANIUM ABUTMENT Ø 3,5mm

Ref. RMM40SEG

- 1 MINI EXTRAGRADE TITANIUM ABUTMENT Ø 4,0mm

€ 29,00



Ref. GCMR

- 1 CASTABLE SLEEVE FOR INCLINED TITANIUM ABUTMENT WITHOUT HOLE Ø 3,5mm

Ref. GCMR4

- 1 CASTABLE SLEEVE FOR INCLINED TITANIUM ABUTMENT WITHOUT HOLE Ø 4,0mm

€ 15,00



Ref. GC

- 1 CASTABLE SLEEVE FOR TITANIUM ABUTMENT Ø 3,5mm

Ref. GC4

- 1 CASTABLE SLEEVE FOR TITANIUM ABUTMENT Ø 4mm

Ref. GC5

- 1 CASTABLE SLEEVE FOR TITANIUM ABUTMENT Ø 5mm

€ 12,00



Ref. GMM

- 1 CASTABLE SLEEVE FOR MINI TITANIUM ABUTMENT Ø 3,5mm

Ref. GMM4

- 1 CASTABLE SLEEVE FOR MINI TITANIUM ABUTMENT Ø 4mm

€ 12,00



Ref. MTFP

- 1 TITANIUM ABUTMENT WITH LATERAL HOLES FOR TEMPORARY RESIN BRIDGE WITH WIRE-REINFORCEMENT h1,8mm (ONLY AVAILABLE WITH Ø 3,5mm)

Ref. MTB30FP

- 1 TITANIUM ABUTMENT WITH LATERAL HOLES FOR TEMPORARY RESIN BRIDGE WITH WIRE-REINFORCEMENT h3mm (ONLY AVAILABLE WITH Ø 3,5mm)

€ 29,00



Ref. HR800

- 1 TITANIUM WIRE WITHOUT ELASTIC MEMORY Ø 1,0mm

€ 7,80



Ref. MEG40C

- 1 EXTRAGRADE CASTABLE ABUTMENT Ø 4,0mm

€ 28,00



Ref. RMCEG15SF

- 1 EXTRAGRADE CASTABLE ABUTMENT WITHOUT HOLE (ONLY AVAILABLE WITH Ø 4,0mm)

€ 28,00



Ref. SM6

- 6 WHITE SEEGERS WITH HANDLE (STANDARD RETENTION)

€ 30,00



Ref. SRM6

- 6 PINK SEEGERS WITH HANDLE (SOFT RETENTION)

€ 30,00



Ref. 022RGO

- 3 CASTABLE CONNECTION BAR

€ 8,00



Ref. FSS

- 1 BUR FOR THE SEEGER HOUSING POLISHING

€ 55,00



Via ZAGO 10/ABC 40128 - BOLOGNA (ITALY)
Tel. (+39) 051 244510 - (+39) 051 244396 Fax (+39) 051 245238
<http://www.rhein83.com>
direzione@rhein83.it